

® = registered trademark of BASF SE

Acoustics Basotect® G

Product description

Basotect® G (light gray) is a flexible, open-cell foam made from melamine resin.

Sound absorption and degree of sound absorption α_s

The open cell surface of the foam ensures that soundwaves can enter the cell structure unimpeded. There, the sound energy is decreased as a result of friction of the air particles that have also been moved rubbing against the angular cell struts. The reduction of this sound energy and conversion into heat energy is described as sound absorption.

The degree of sound absorption (sound absorption coefficient) hereby defines the ratio of reflected to absorbed sound energy and subject to the material and its thickness, is frequency-dependant. It can be ascertained in two different ways:

- A) In an impedance tube (Kundt's tube) according to the international standard DIN EN ISO 10534
Part 1: Method using standing wave ratio (ISO 10534-1:1996)
Part 2: Transfer function method (ISO 10534-2:1998)
- B) In a reverberation room according to the international standard DIN EN ISO 354

At the end of a measurement in an impedance tube, for 18 individual frequencies between 100Hz and 5000Hz, you will find the degree of sound absorption α_s , a number between 0 and 1, whereby 0 means 100% reflection and 1 means 100% absorption. Whereas in the impedance tube the degree of absorption does not exceed a value of 1 due to soundwaves only penetrating vertically, in the reverberation room, in a diffuse sound field it can be metrologically larger than 1. This phenomenon that repeatedly causes confusion can be explained by the bending of the soundwaves around the edges of the test specimen at the borders of the test surface, whereby the effective absorption surface stretches beyond its actual geometric base area. The thicker the material to be tested is, the stronger this effect will be.

Test results from the acoustic trials in the impedance tube according to ISO 10534-2 and in the reverberation room according to DIN EN ISO 354 are shown in diagrams 1 and 2. In addition to that, the degrees of sound absorption α_s measured in third octave bands according to ISO 354 as well as the corresponding practical degree of sound absorption α_p (see separate definition) according to ISO 11654 are shown in Table 1.

Repeat measurements and regular quality control in the production of Basotect G shows that the acoustic values remain within a tight tolerance range. This small scatter of the characteristic data for the material makes Basotect G a reliable and enduring acoustically effective absorber.

Diagram 1: Degree of sound absorption α_s of Basotect® G depending in the thickness according to ISO 10534-2 (impedance tube)

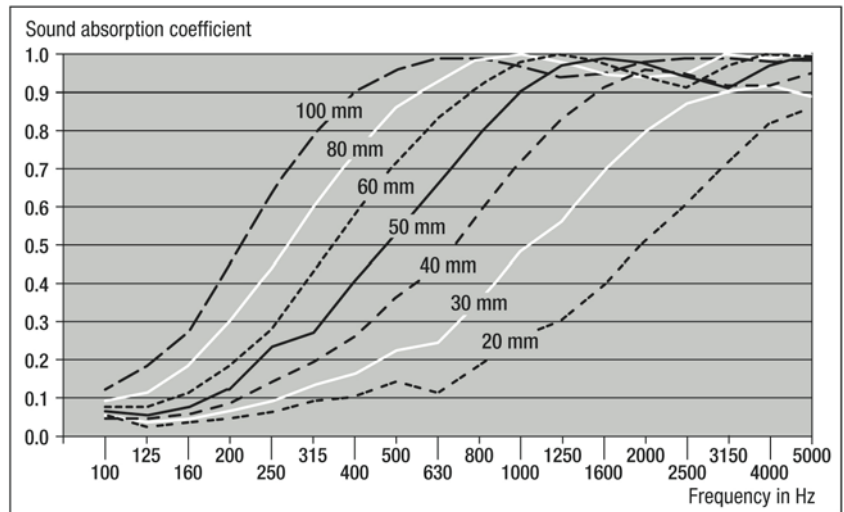
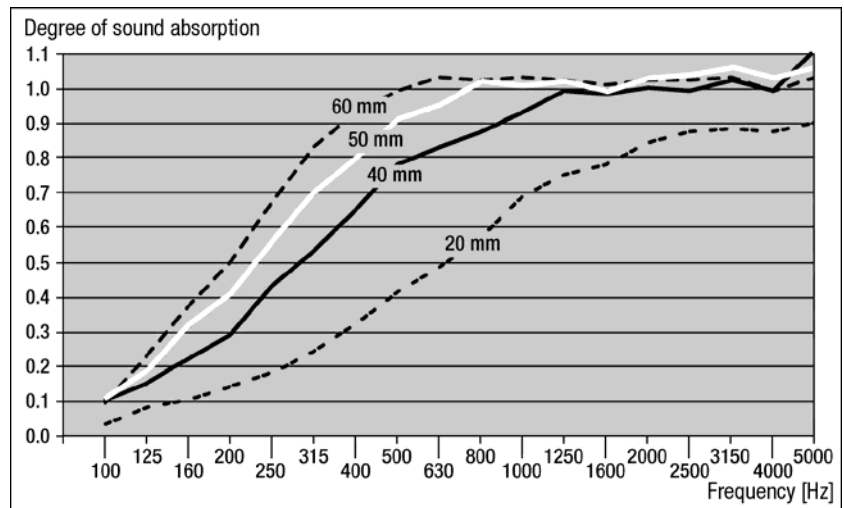

Diagram 2: Degree of sound absorption α_s of Basotect® G depending in the thickness according to DIN EN ISO 354 (reverberation room)



Note:

Please note that a change in the surface e.g. by coating or laminating with cloth or textiles can affect the degree of sound absorption.

Table 1: Individual sound absorption values α_s in third octave bands according to DIN EN ISO 354 and the corresponding practical degree of sound absorption α_p for every octave band according to DIN EN ISO 11654 depending on the thickness for Basotect® G

Frequency [Hz]	20 mm		40 mm		50 mm		60 mm	
	α_s 3 rd	α_p Octave	α_s 3 rd	α_p Octave	α_s 3 rd	α_p Octave	α_s 3 rd	α_p Octave
100	0.03		0.10		0.11		0.09	
125	0.08	0.05	0.15	0.15	0.19	0.20	0.23	0.25
160	0.10		0.22		0.32		0.37	
200	0.14		0.29		0.41		0.50	
250	0.18	0.20	0.43	0.40	0.56	0.55	0.67	0.65
315	0.24		0.53		0.70		0.83	
400	0.32		0.65		0.80		0.93	
500	0.41	0.40	0.78	0.75	0.91	0.90	0.99	1.00
630	0.48		0.83		0.95		1.03	
800	0.57		0.87		1.02		1.02	
1000	0.69	0.65	0.93	0.95	1.01	1.00	1.03	1.00
1250	0.75		0.99		1.02		1.02	
1600	0.78		0.98		0.99		1.01	
2000	0.84	0.85	1.00	1.00	1.03	1.00	1.02	1.00
2500	0.87		0.99		1.04		1.02	
3150	0.88		1.02		1.06		1.03	
4000	0.87	0.90	0.99	1.00	1.03	1.00	0.99	1.00
5000	0.90		1.11		1.06		1.03	

Practical degree of sound absorption α_p

The practical degree of sound absorption α_p can be calculated for every octave band from the arithmetic mean of the degree of sound absorption α_s of the three third band octaves within the octave. The average value is calculated to the second decimal point, is rounded in steps of 0.05 and maximized to $\alpha_{pi} = 1.00$ for rounded average values greater than 1.00.

$$\alpha_{pi} = \frac{\alpha_{i1} + \alpha_{i2} + \alpha_{i3}}{3}$$

Weighted degree of sound absorption α_w and sound absorption categories

DIN EN ISO 354 does not determine any derived practical absorption coefficients from the individual frequencies. For this purpose, the international standard DIN EN ISO 11654 can be applied, according to which a weighted degree of sound absorption α_w is determined using a method set out in the speech relevant frequency range between 250 Hz and 4000 Hz. The weighted degree of sound absorption α_w is defined as the value of the shifted reference curve at 500 Hz.

Figure 1: Display of the reference curves that limit the various sound absorption classes

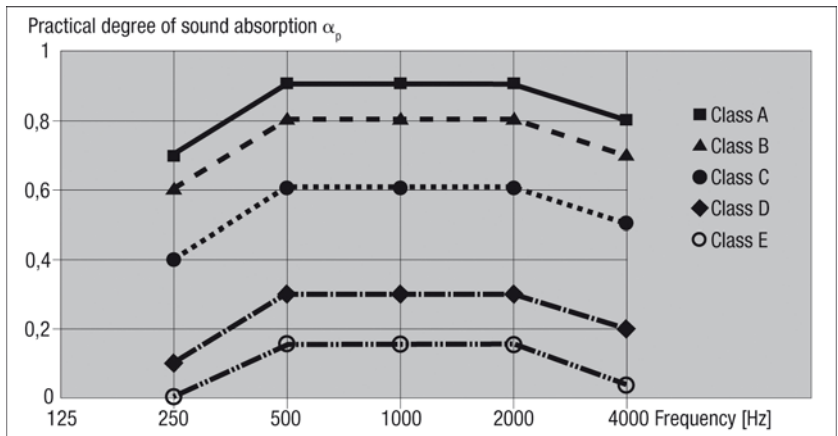

The reference curve needs to be shifted in steps of 0.05 in the direction of the measured values until the sum of the unfavorable variances is ≤ 0.10 . An unfavorable variance at a certain frequency is given if the measurement value is lower than the reference value. Examples of this can be found in DIN EN ISO 11654.

However, if the practical degree of sound absorption of the absorber clearly exceeds this reference curve by 0.25 or more, i.e. the measured absorption values of the absorber are significantly better, then in addition to that, a form indicator is given in brackets. The description L is used if the absorption is exceeded at 250 Hz. The description M is used if the absorption is exceeded at 500 Hz or 1000 Hz and the description H is used if it is exceeded at 2000 Hz or 4000 Hz.

The informative appendix B to DIN EN ISO 11654 continues to contain a classification of the individual data α_w in the following absorption classes.

Sound absorption class	Values α_w
A	0.90; 0.95; 1.00
B	0.80; 0.85
C	0.60; 0.65; 0.70; 0.75
D	0.30; 0.35; 0.40; 0.45; 0.50; 0.55
E	0.15; 0.20; 0.25
not classified	0.00; 0.05; 0.10

The evaluation of the test results according to DIN EN ISO 11654 as well as the sound absorption classes for Basotect® G are shown in Table 2.

**Noise Reduction Coefficient
NRC**

The arithmetic average degree of sound absorption at the octave band average frequency of 250, 500, 1000 and 2000 Hz is called the noise reduction coefficient NRC. The value is used to identify products made of sound absorbing materials.

$$NRC = \frac{\alpha_{p250} + \alpha_{p500} + \alpha_{p1000} + \alpha_{p2000}}{4}$$

Table 2: Individual sound absorption values α_w and sound absorption classes of Basotect® G depending on the thickness according to DIN EN ISO 11654 as well as the Noise Reduction Coefficient NRC according to the American standard ASTM C 423

Basotect® G thickness [mm]	Individual value α_w according to DIN EN ISO 11654	Sound absorption class according to Appendix B of DIN EN ISO 11654	Noise Reduction Coefficient NRC acc. to ASTM C 423
20	0.45 (H)	D	0.55
40	0.70 (M,H)	C	0.80
50	0.85 (H)	B	0.90
60	0.95	A	0.95

Note:

Whenever an additional form indicator is given, we strongly recommend always using the single figure weighting according to DIN EN ISO 11654 and only in connection with the complete curve of the degree of sound absorption.

Measurements according to the American standard ASTM C 423 can result in higher values as the ratio of edge length / test surface is greater than with EN ISO 354.

Degree of sound absorption due to system

In the medium and high frequency range, Basotect® G is extremely good at absorbing sound. For lower frequencies, right down to the lower cutoff frequency of 100 to 125, the typical mode of action of an open cell absorber becomes noticeable. This can slow the air particles most effectively if the sound particle velocity, or in other words the current velocity of a vibrating particle is at its greatest. If a sound wave hits a reverberating wall at right angles to it, the sound particle velocity reaches its maximum a quarter of a wavelength away from the wall. Consequently, due to the long waves in the lower frequency range, the absorber has to be of a certain thickness to be able to work effectively.

Sound technological improvements with lower cutoff frequencies for example can be attained through an additional heavier material. Alternatively, it is also possible to affix a thinner absorber made of Basotect G with defined wall clearance so that the maximum of the sound particle velocity is in the foam again and noise is additionally absorbed due to resonance of the air volume. This effect is shown in diagram 3 and 4. The corresponding absorption measurement values and the evaluation according to ISO 11654 can be seen in Table 3 and 4.

Figure 2: Basotect® with heavier material

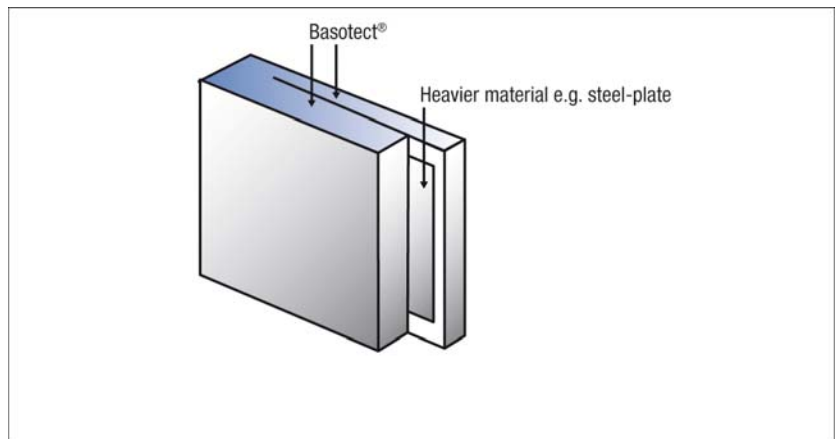
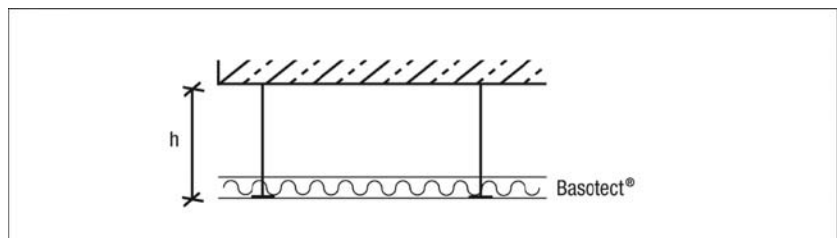

Figure 3: Suspended ceiling with Basotect®



The construction heights h of 200 and 400 mm that are used correspond to structure type E-200 and E-400 according to Appendix B to ISO 354. E is the distance in mm between the surface exposed to the noise and the floor of the reverberation room.

Diagram 3: Degree of sound absorption α_s of Basotect® G in the thickness 20 mm with a construction depth of 200 mm and 400 mm according to DIN EN ISO 354 (reverberation room) in comparison to a measurement without airspace.

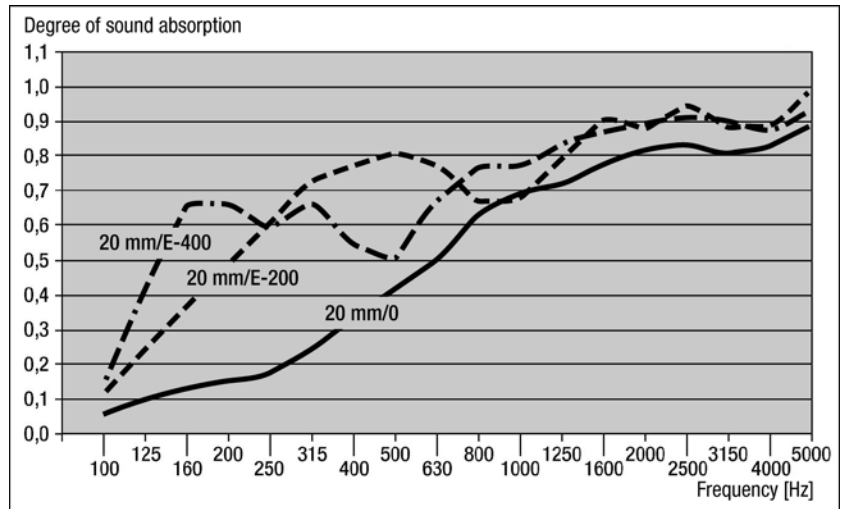

Diagram 4: Degree of sound absorption α_s of Basotect® G in the thickness 50 mm with a construction depth of 200 mm and 400 mm according to DIN EN ISO 354 (reverberation room) in comparison to a measurement without airspace.

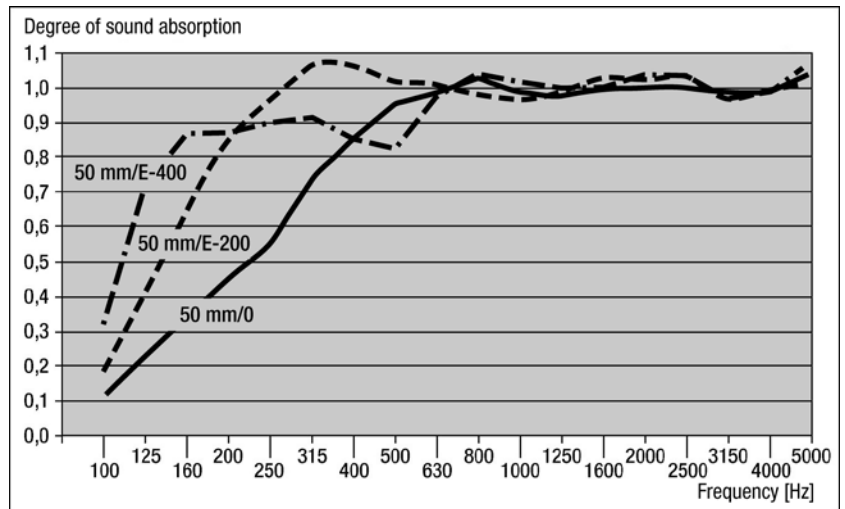

Table 3: Individual sound absorption values α_s in third octaves according to DIN EN ISO 354 as well as the corresponding practical degree of sound absorption α_p for every octave band according to DIN EN ISO 11654 of Basotect® G depending on the depth of construction and thickness.

Frequency [Hz]	Depth of construction 200 mm				Depth of construction 400 mm			
	20 mm		50 mm		20 mm		50 mm	
	α_s 3 rd	α_p Octave	α_s 3 rd	α_p Octave	α_s 3 rd	α_p Octave	α_s 3 rd	α_p Octave
100	0.12		0.18		0.15		0.31	
125	0.27	0.25	0.40	0.40	0.41	0.40	0.71	0.65
160	0.37		0.63		0.65		0.87	
200	0.50		0.86		0.65		0.87	
250	0.60	0.60	0.96	0.95	0.59	0.65	0.90	0.90
315	0.72		1.07		0.65		0.91	
400	0.77		1.06		0.54		0.85	
500	0.80	0.80	1.10	1.00	0.50	0.55	0.81	0.90
630	0.77		1.01		0.67		0.98	
800	0.66		0.98		0.77		1.04	
1000	0.66	0.70	0.97	1.00	0.77	0.80	1.02	1.00
1250	0.79		0.99		0.83		1.00	
1600	0.90		1.03		0.87		1.00	
2000	0.88	0.90	1.01	1.00	0.89	0.90	1.03	1.00
2500	0.94		1.03		0.91		1.03	
3150	0.88		0.97		0.90		0.98	
4000	0.88	0.90	0.99	1.00	0.88	0.90	0.99	1.00
5000	0.97		1.01		0.92		1.05	

Table 4: Individual sound absorption values α_w and sound absorption classes of Basotect® G depending on depth of construction and the thickness according to DIN EN ISO 11654 as well as the Noise Reduction Coefficient NRC according to the American standard ASTM C 423

Basotect® G thickness [mm]	Depth of construction	Individual value α_w according to DIN EN ISO 11654	Sound absorption class according to Appendix B of DIN EN ISO 11654	Noise Reduction Coefficient NRC according to ASTM C 423
20	200	0.80	B	0.75
	400	0.65 (H)	C	0.70
50	200	1.00	A	1.00
	400	1.00	A	0.95

Room acoustics

Due to its open cell structure, the melamine resin foam Basotect® G is an excellent sound absorber to optimize room acoustics in buildings. The DIN 18041 "Acoustic quality small to medium-sized rooms" here predominantly defines the acoustic requirements and planning guidelines for ensuring audibility for speech communication, including the measures it is necessary to take to achieve this. The most well-known criterion for room acoustics to qualify the noise dispersion in a room is probably the reverberation period. It is a gauge for the reverberation in a room and is defined as the period of time it takes for sound pressure in the room to reduce by 60 dB after the noise source has been switched off.

The acoustic quality of a room is hereby predominantly determined depending on the use by the following factors:

- The geometric arrangement of the room, the ratio of length to width and to height
- The existence or respectively distribution of sound absorbing and sound reflecting surfaces
- The sound pressure level of all noise acting on it

The reverberation period For further information and recommendations on regulating reverberations periods and also about arranging absorbers on ceilings and walls can be found in the Basotect Acoustics brochure.

Note

The data contained in this publication are based on our current knowledge and experience. In view of the many factors that may affect processing and application of our product, these data do not relieve processors from carrying out their own investigations and tests; neither do these data imply any guarantee of certain properties, nor the suitability of the product for a specific purpose. Any descriptions, drawings, photographs, data, proportions, weights, etc. given herein may change without prior information and do not constitute the agreed contractual quality of the product. It is the responsibility of the recipient of our products to ensure that any proprietary rights and existing laws and legislation are observed.